

Technical data sheet

Intermediate clamp for PV module mounting, free-standing system

Item number: 5901058



Connection clamp for fastening photovoltaic modules on support profiles of free-standing systems. Lockable pre-fastening of the module frames on the support profile. Suitable for slot width 10 mm. Lockable fastening of the PV module with Torx 30 wrench.

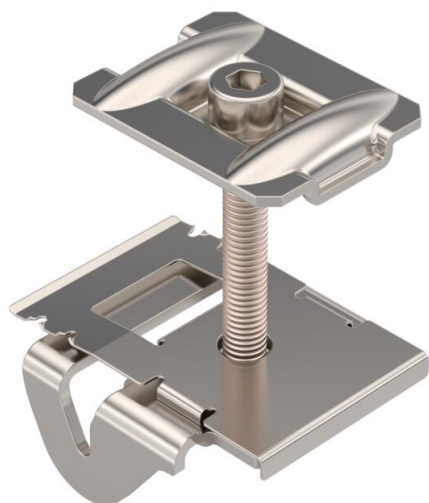

A2 Stainless steel

Master data

Item number	5901058
Description 1	Intermediate clamp
Description 2	for free-standing system
Manufacturer	OBO
Dimension	83x54x66
Colour	stainless steel
Material	Stainless steel
Smallest sales unit	50
Unit of quantity	Piece
Weight	14.8 kg
Weight unit	kg/100 pc.

Technical data sheet

Intermediate clamp for PV module mounting, free-standing system

Item number: 5901058



Dimensions

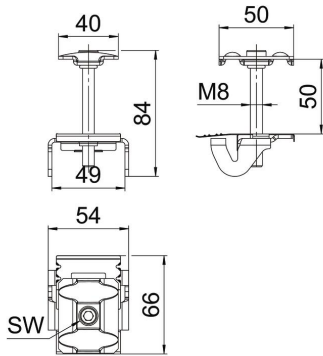

Width	54 mm
Height	84.5 mm

Technical data

With fastening material	no
Depth	66 mm
Adjustable	yes
Photovoltaic connection and fastening element version	Centre clamp
For frame height min.	40 mm
For frame height max.	50 mm
With module earthing	no